

Kwarc 203 - 2M

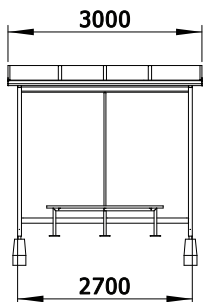

PRWK203PPALL

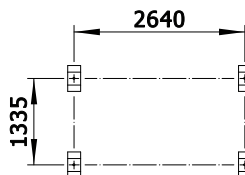

PRWK203CCALL

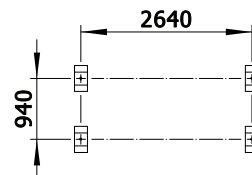

Kwarc 205 - 3M

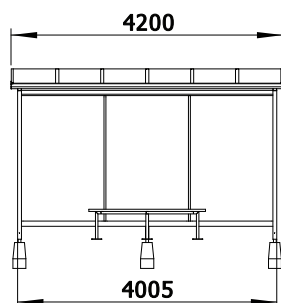

PRWK205PPALL

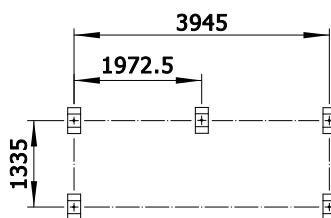

PRWK205CCALL

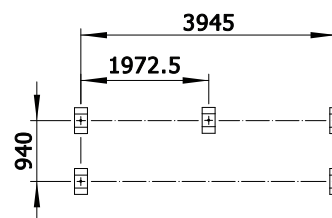

Kwarc 207 - 4M

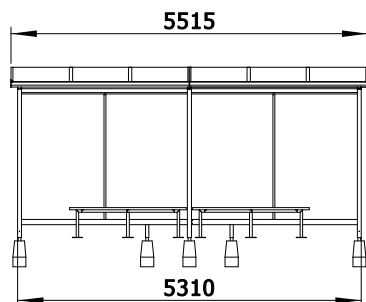

PRWK207PPALL

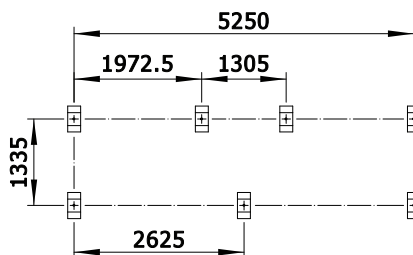

PRWK207PPALL

